

F 015 051 001

Stand } 05-10-05  
Issue }

**Fig./Abb. 1**

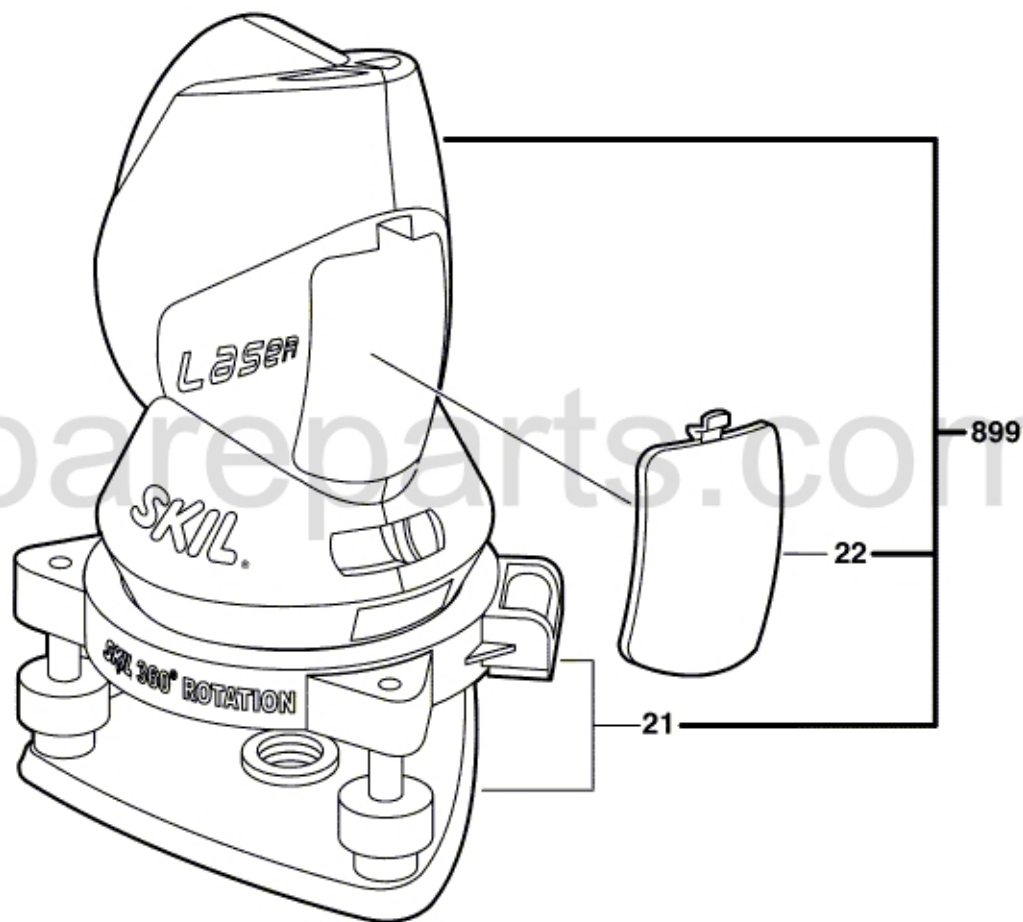

Änderungen vorbehalten  
Modifications reserved  
Modifications réservées  
Salvo modificaciones